



Investigation of “Smart Parts” with Embedded Sensors for Energy System Applications

THE UNIVERSITY OF TEXAS
AT EL PASO

Jose A. Gonzalez
Yirong Lin, Ryan Wicker, Ahsan
Choudhuri



Agenda



- Introduction and Background
- Objectives
- Technical Approach
- Results
- Summary
- Future Work

Motivation

- Highly efficient and environmentally benign power and fuel systems require:
 - Critical Sensing in modern power plants and energy systems
 - Higher efficiencies in energy conversion
 - Lower emission for near-zero emission power plants
 - Enhanced material systems safety

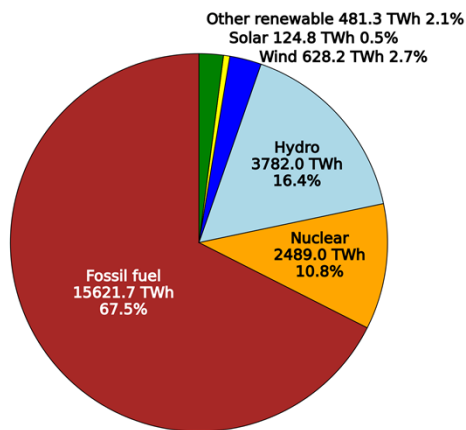

World Electricity Generation by Source (2013)



U.S. 2013 Electricity Generation By Type

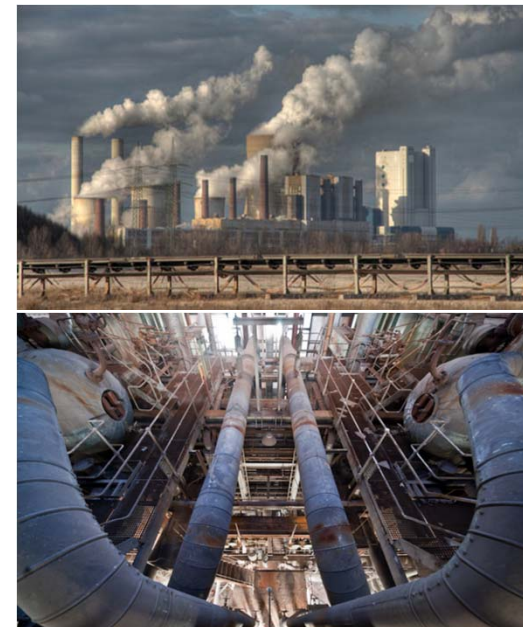
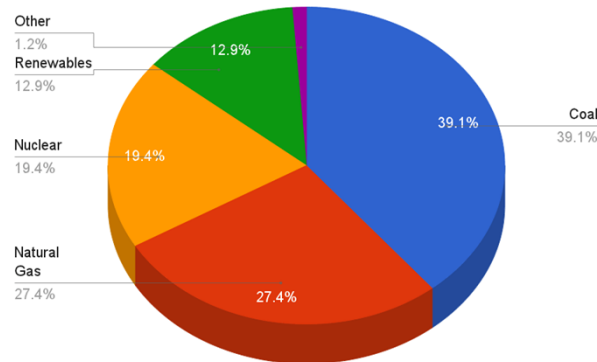

- Harsh high temperature conditions are common to the efficient conversion of fuels and processes for environmental control
- Monitoring/estimating harsh conditions in real time is needed for high system performance and assessing reliability

Gasifiers

- Up to 1600°C
- Up to 1000 PSI
- Erosive, corrosive, highly reducing

Combustion Turbines

- Up to 1350°C
- Pressure ratios of 30:1
- Thermal shock, highly oxidative
- Complex geometries

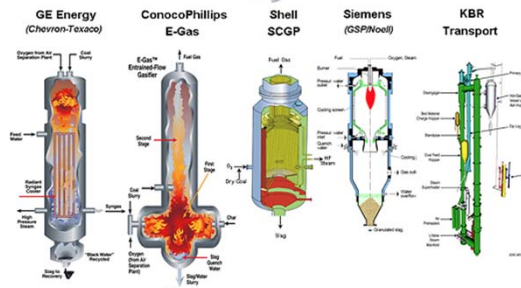
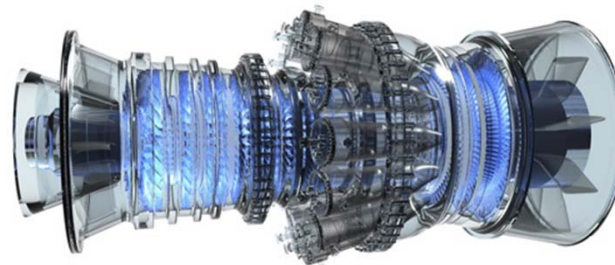
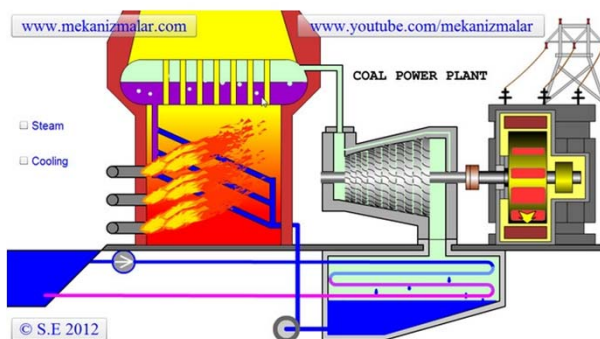

- Integrated thermocouples bonded to turbine blades
- Temperature measurement enabled
- Signal is sensitive to harsh environments
- Up to 1400 °C for short time

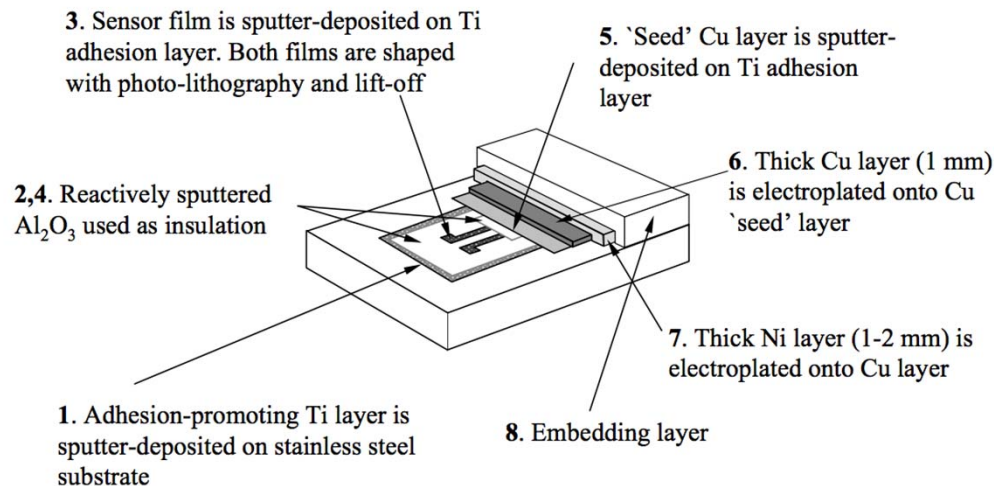

(X. Li, 2001)

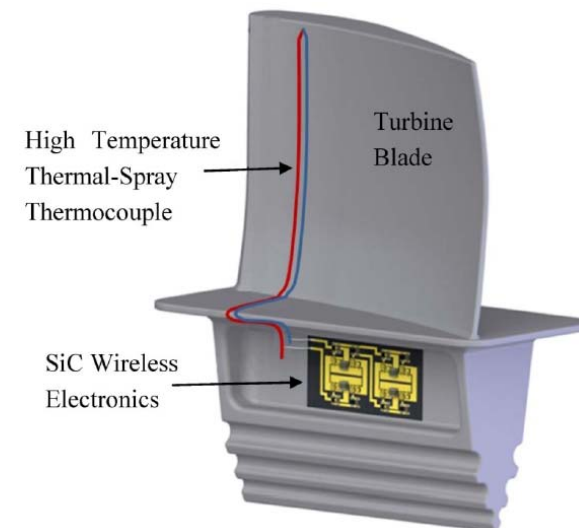

(J. Yang, 2012)

Overview and Rationale

- “Smart parts” with embedded sensor
 - Built-in monitoring capability
 - Accurate sensing at desired location
 - No change required post fabrication
 - Realized by 3D printing technology

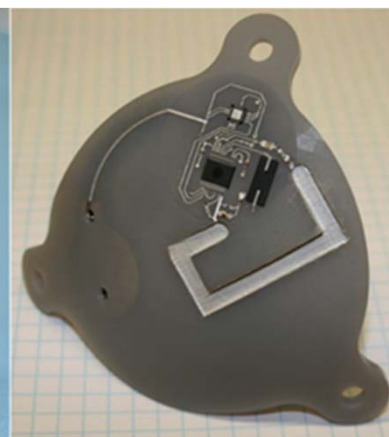
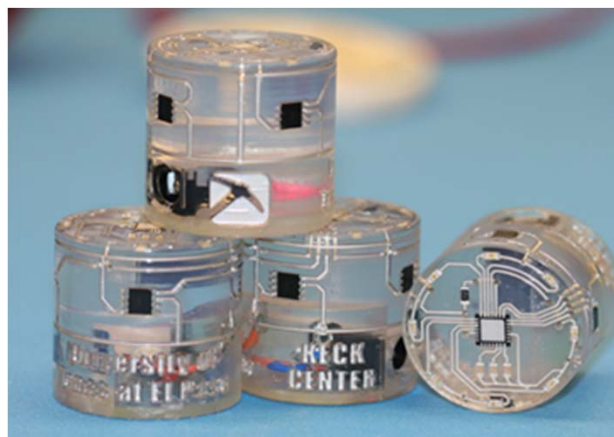
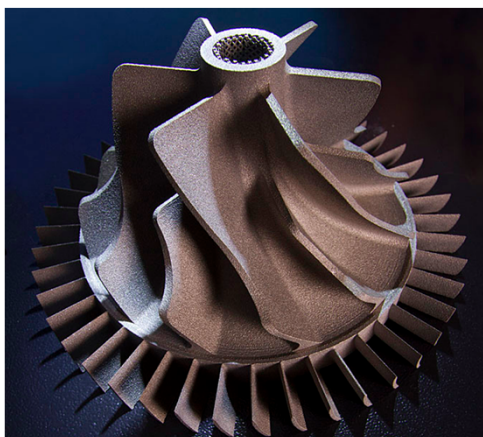

Scope of Work

- Design and fabricate “smart parts” with embedded sensors
 - EBM 3D printing technique for fabrication of “smart parts”
 - Piezoceramic sensors for temperature, strain, pressure, and structural health conditions
- Evaluate the sensing capability of the “smart part” in realistic energy systems

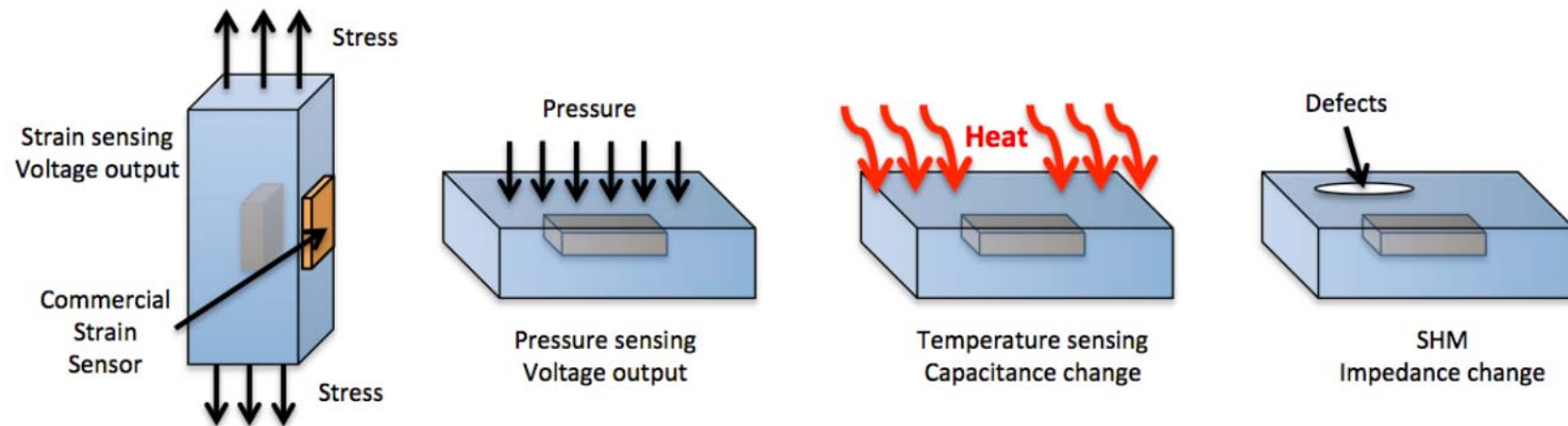

Objectives

- **Objective 1: Fabricate energy system related components with embedded sensors**
 - Fabrication & evaluation of components without sensor by Electron-Beam Melting (EBM)
 - Manufacturing “Smart Parts” with embedded sensor by EBM

- **Objective 2: Evaluate the mechanical properties and sensing functionalities of the “smart parts” with embedded piezoceramic sensors**
 - Evaluation of interfacial shear properties
 - Characterization of the sensing capability

- **Objective 3: Assess in-situ sensing capability of energy system parts**
 - Short & long term testing to determine sensor reliability
 - Cyclic and constant loading to determine the sensing repeatability and stability



Additive Manufacturing

- Additive Manufacturing is a process for creating parts directly from a computer model based on 3D Printing technologies
 - Builds complex, functional parts designed in a 3D CAD program
 - Eliminates variation of properties across scales
 - Wide range of applications: ceramic molds, structural ceramic parts, parts for tooling, ceramic preforms for metal matrix composites, etc.

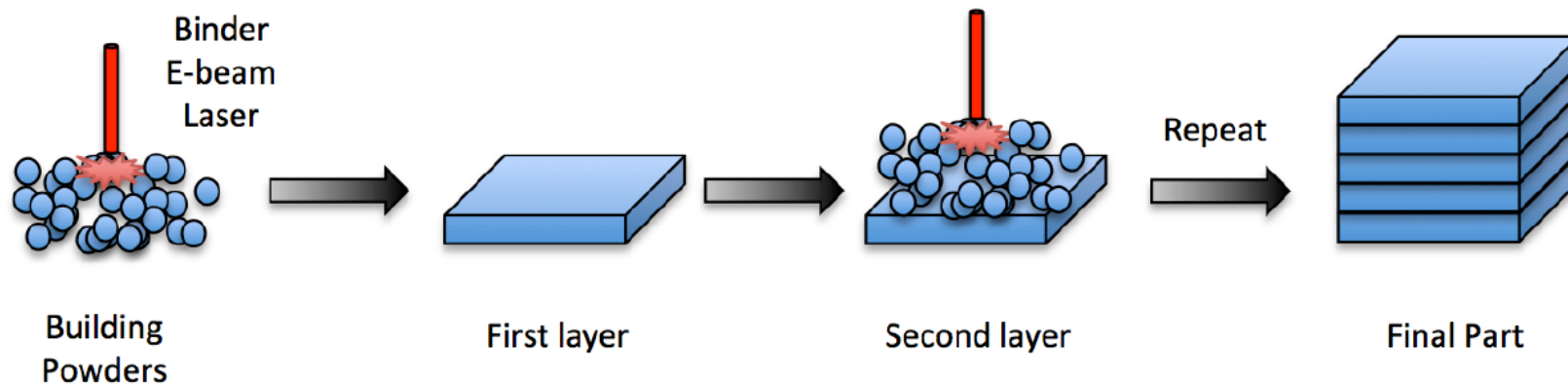



EBM Demo



- “Stop and Go” process, first of its kind
- EBM fabricated manually interrupted
- Sensor embedded during fabrication at desired location

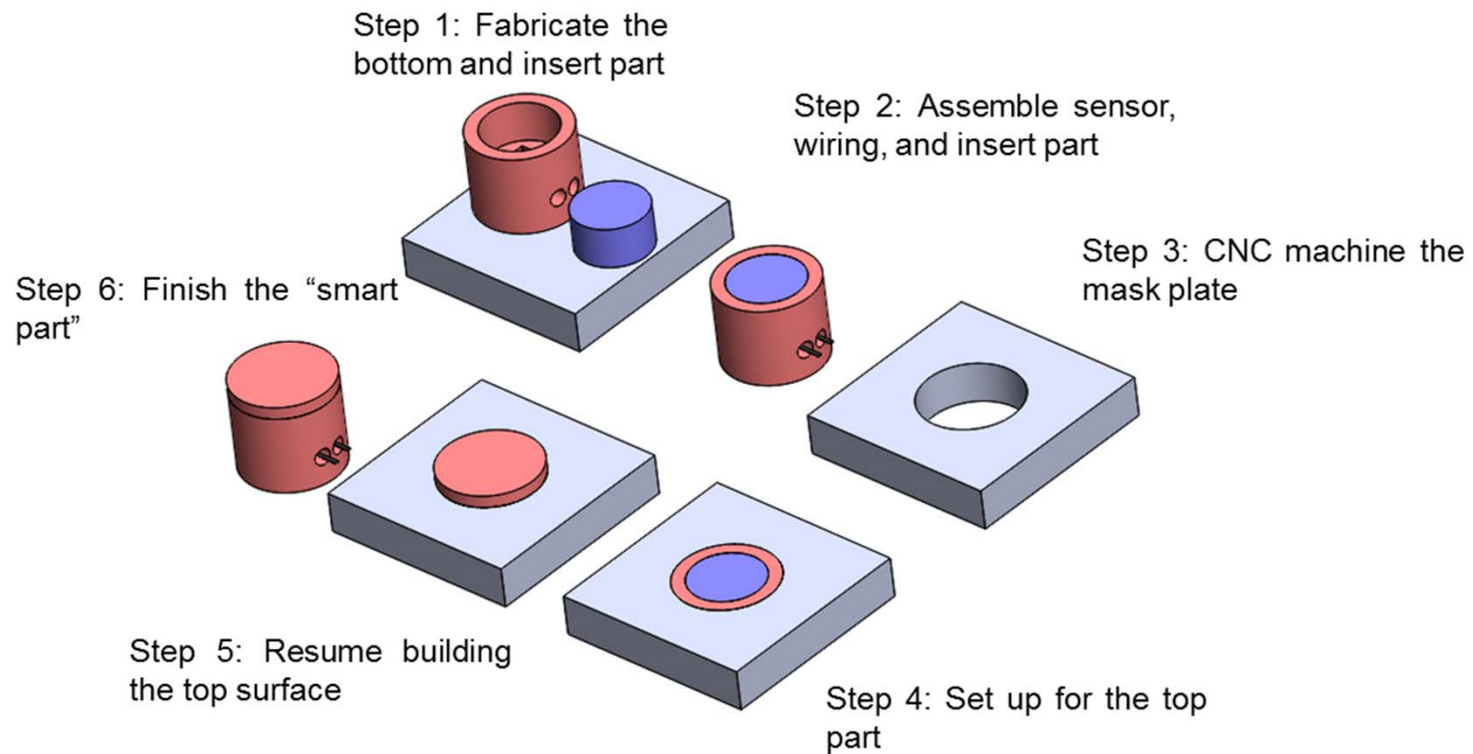

- Piezoceramic for sensing
 - Piezoelectric elements are used in smart systems due their capability of coupling energy in mechanical, thermal, and electrical domain
 - Most of applications rely on relative magnitudes of voltage, or frequency spectrum of signal modified by sensor
 - LiNbO_3 , $T_c = 1200\text{ }^\circ\text{C}$

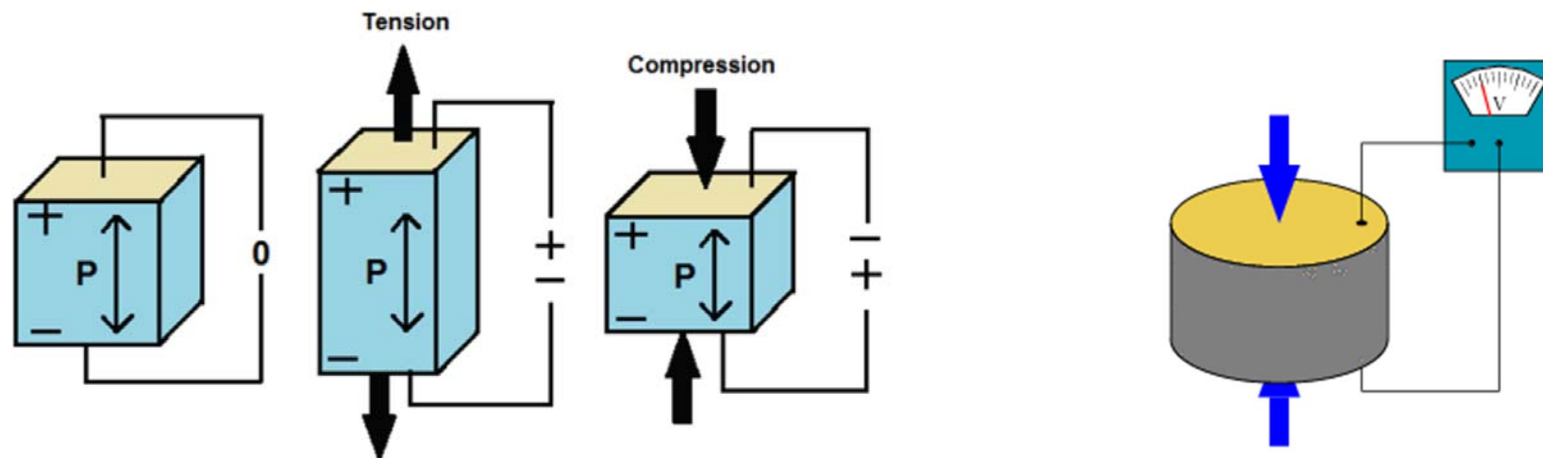

- Powder Material: Ti-6Al-4V
- Mask Plate and Start Plate: Stainless steel
- Layer Thickness: 50 μm



Arcam EBM

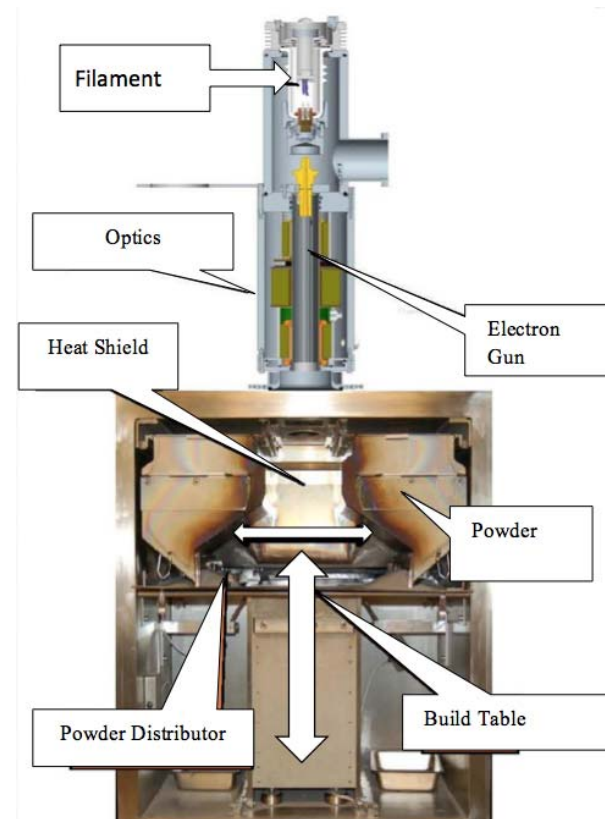

Cross-section view

Sensor assembly in “Smart parts”

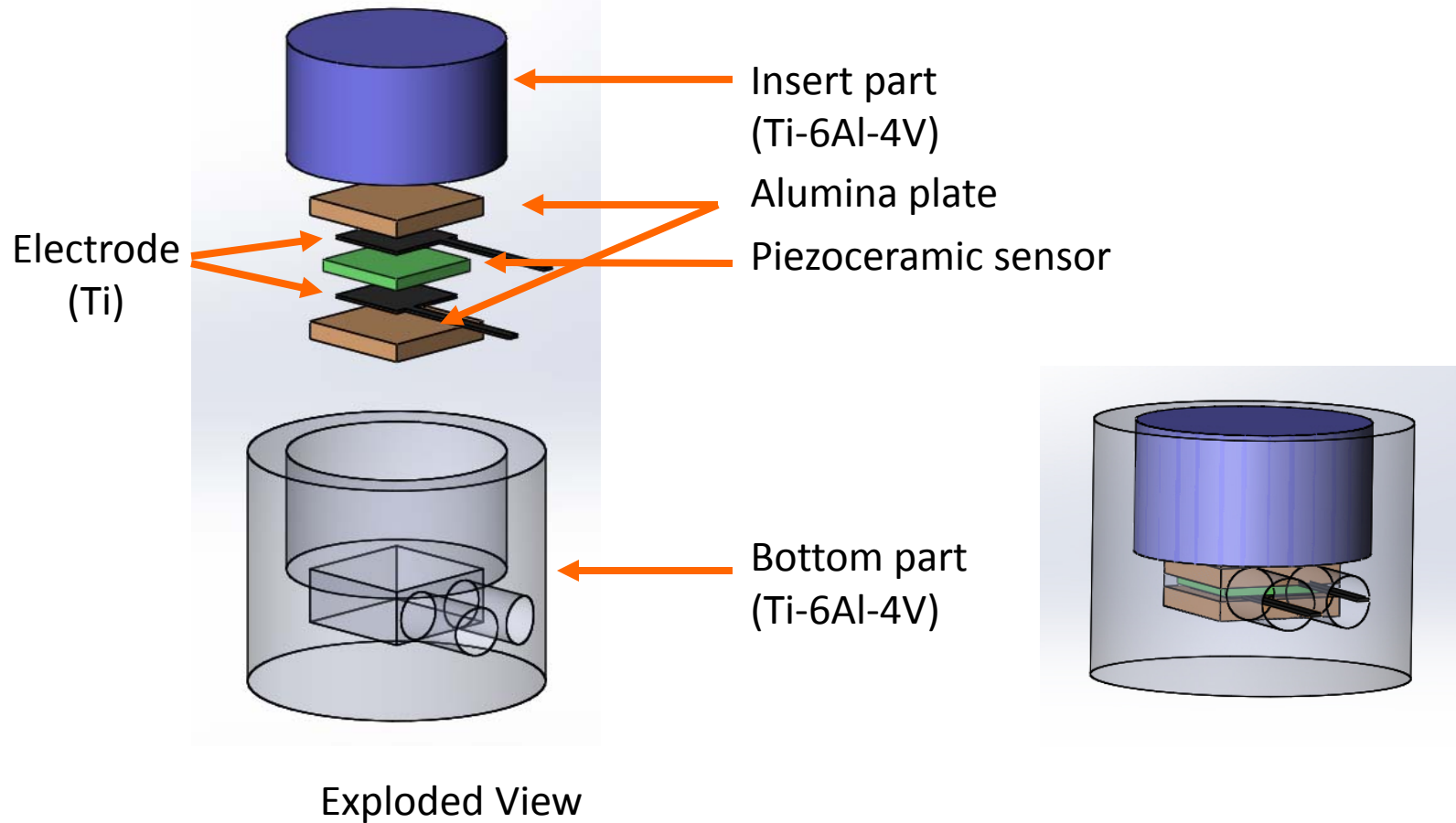

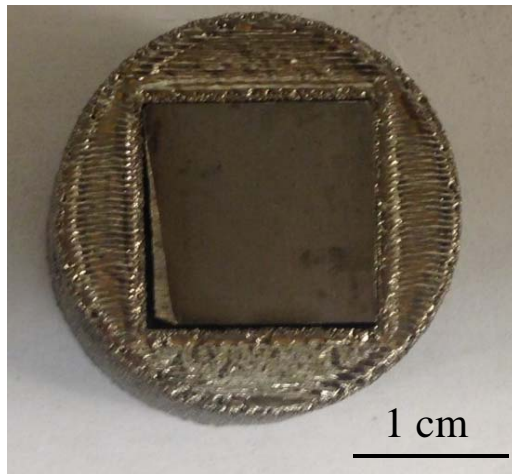

Bottom part

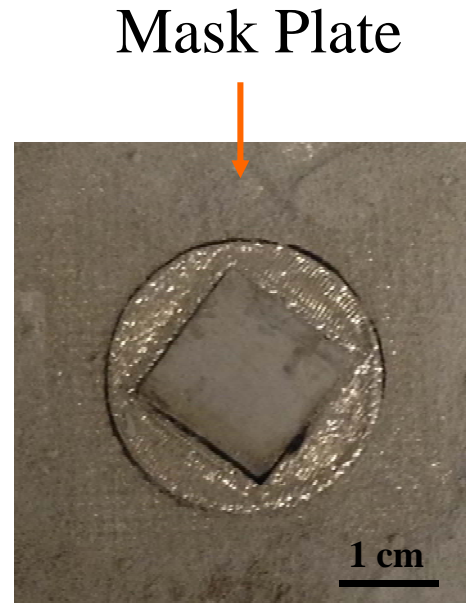

Part press fitted into the mask plate
(150 mm × 150 mm)

Misalignment of
435 μm



Final “smart parts”

Design A



Assemble of parts



After 2nd Fabrication of parts (top view)



After 2nd fabrication of parts (side view)



Dissemble of the top parts

- Important Notes:
- Top part fell off

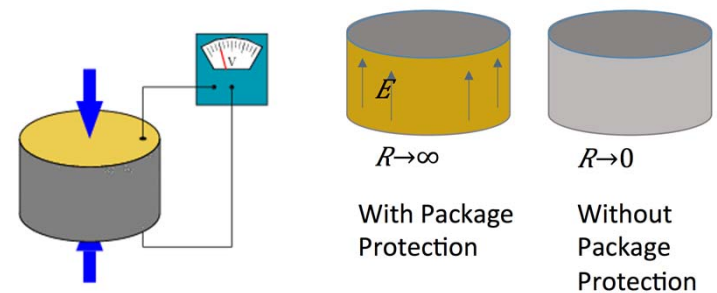

Design B



Assemble of part
(Top View)



Assemble of part
(Side View)



2nd fabrication of part
(Top View)



Build part (Side View)

Important Notes:

- A misalignment of 1.15 mm was obtained due to the centering of the beam offset

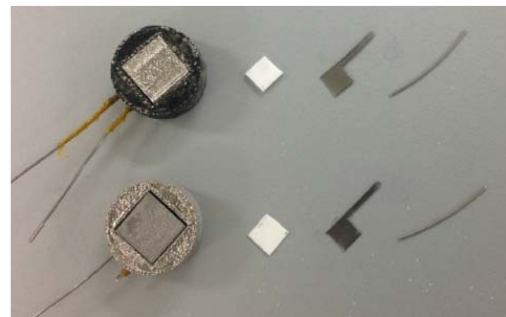

Fabricated parts

Alumina cloth to seal the sensor assembly from metal powder

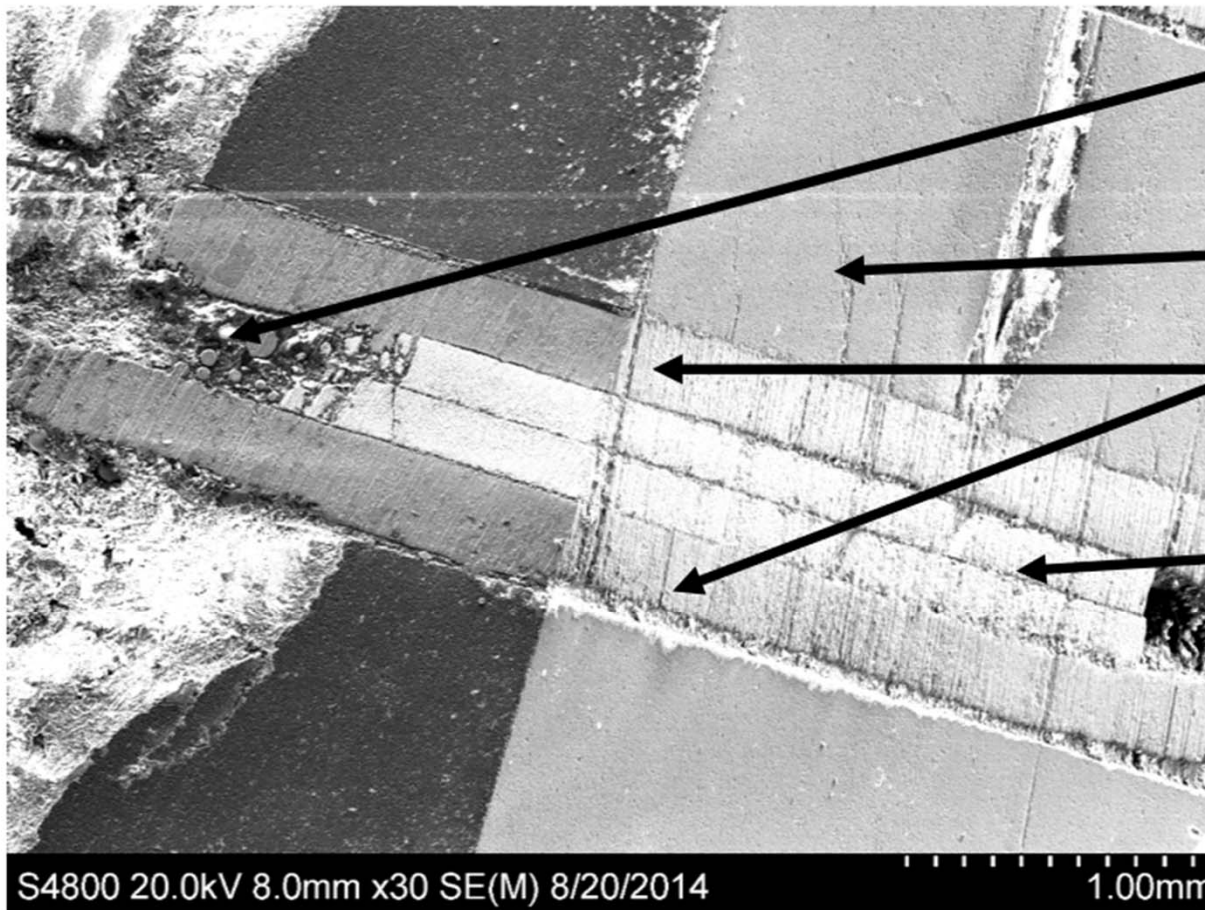

Ti-6Al-4V powder

Alumina plate

Titanium Electrodes

PZT Sensor

- Sensor Electrically shorted
- No sensing could be performed

Characterization

Before EBM

Alumina Plate

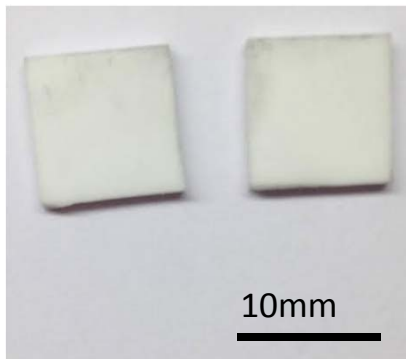

Ti Electrodes

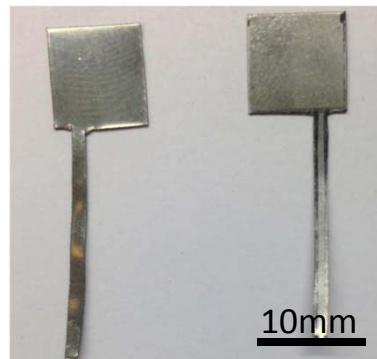

PZT Sensor

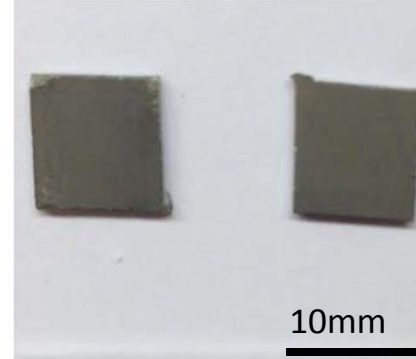

Alumina Sleeve



After EBM

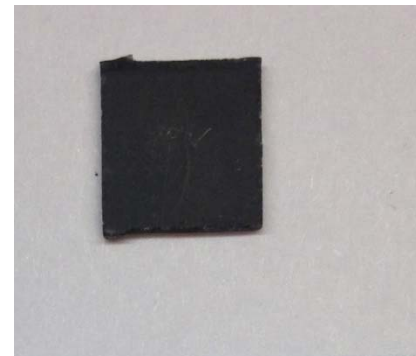

EDS on Alumina Plates(Before EBM)

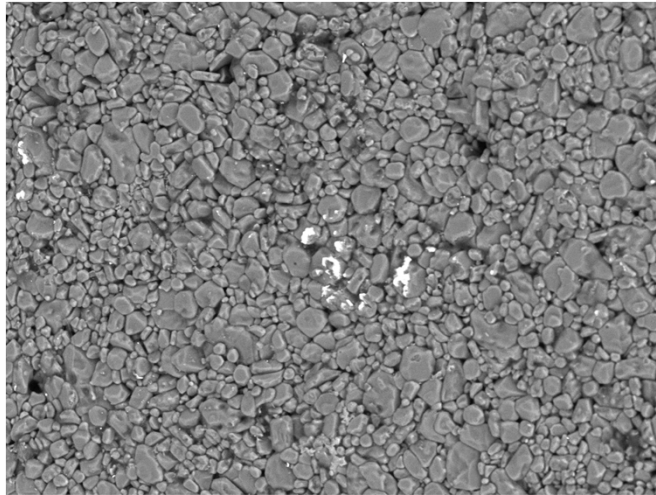

TM-1000_0862 2014/09/18 L x1.0k 100 um

Element	Weight %
Aluminum	98.5
Silicon	1.5

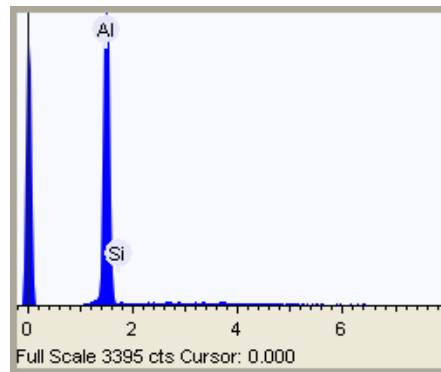

EDS on Alumina Plates(After EBM)

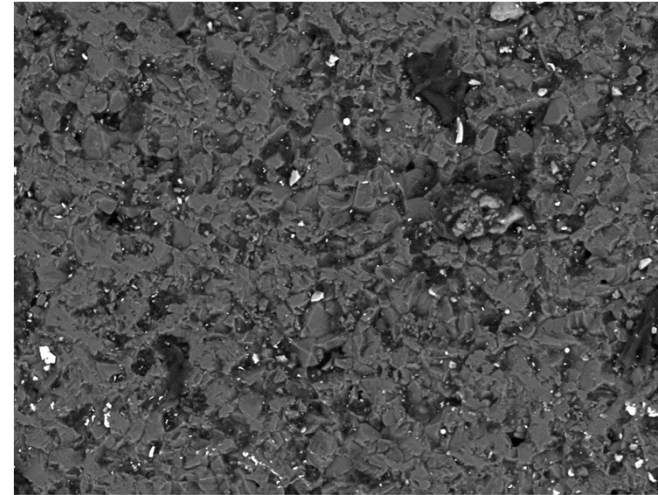

TM-1000_0868 2014/09/18 L x1.0k 100 um

Element	Weight %
Aluminum	89.3
Silicon	3.6
Titanium	4.2

Titanium detected on alumina plate

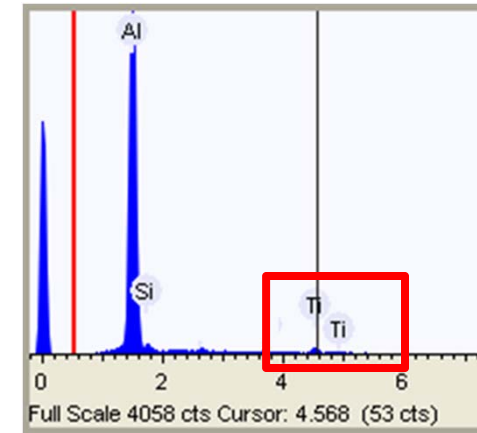



Vaporization temperature of different materials

Element	Vaporization Temperature (C) At Pressure (Torr)				
		10^{-4}	10^{-3}	10^{-2}	10^{-1}
Copper		1035	1141	1273	1432
Gold		1190	1316	1465	1646
Iron		1195	1310	1447	1602
Platinum		1744	1904	2090	2293
Titanium		1250	1384	1546	1742
Tungsten		2767	3016	3309	
Yttrium		1362	1494	1650	1833
Niobium		2355	2539		
Nickel		1257	1371	1510	1679

Mask plate fabrication with isolation cup

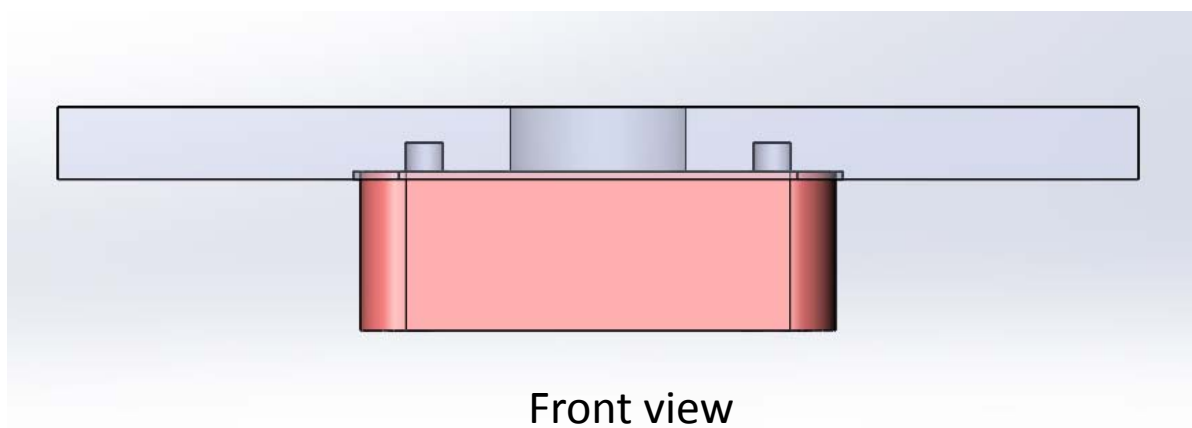
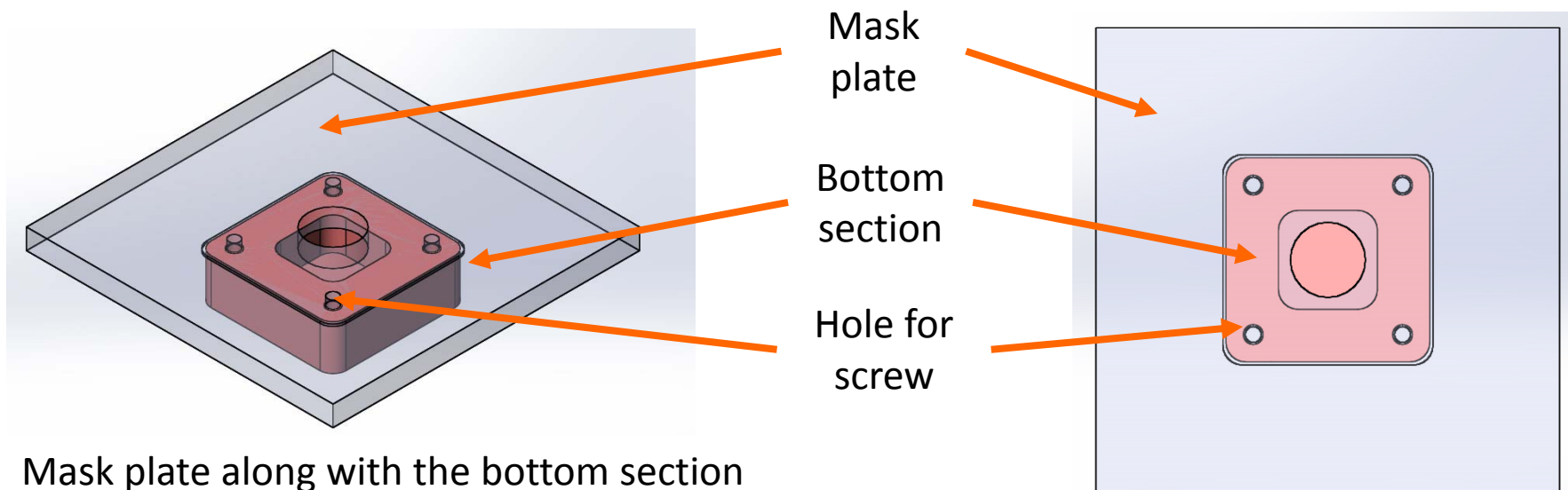

Addition of isolation cup to start plate

- Mask plate was machined using CNC
- Bottom cap made of 304 Stainless Steel
- Bolts: 316 Stainless Steel socket head cap screws
- Used to avoid metal powder from entering in sensor box

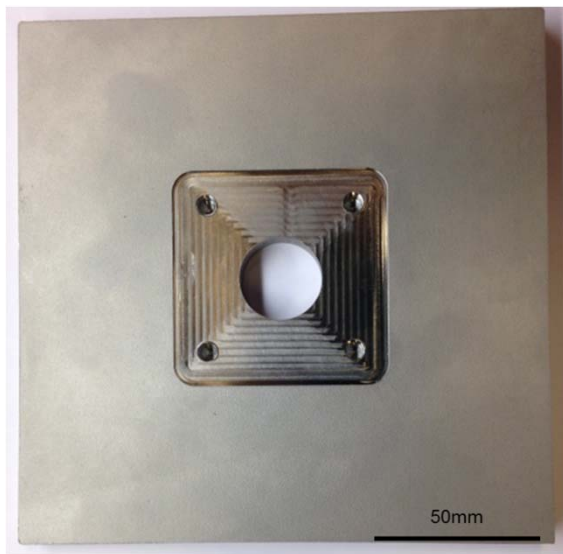

Machined Mask Plate



Isolation Cup

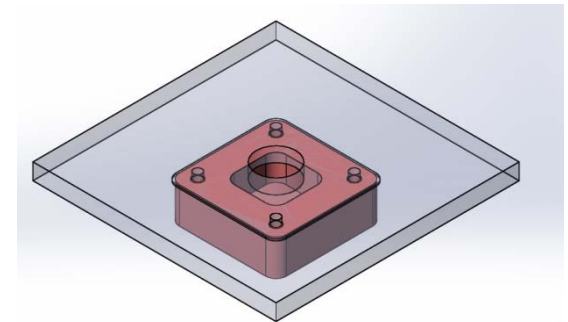

Sensor components within isolation cup

- **NO ELECTRODES PRESENT**
- Alumina cloth, alumina plates, PZT, and sleeves were present within isolation cup during build
- Metal coating was **still visible** on parts

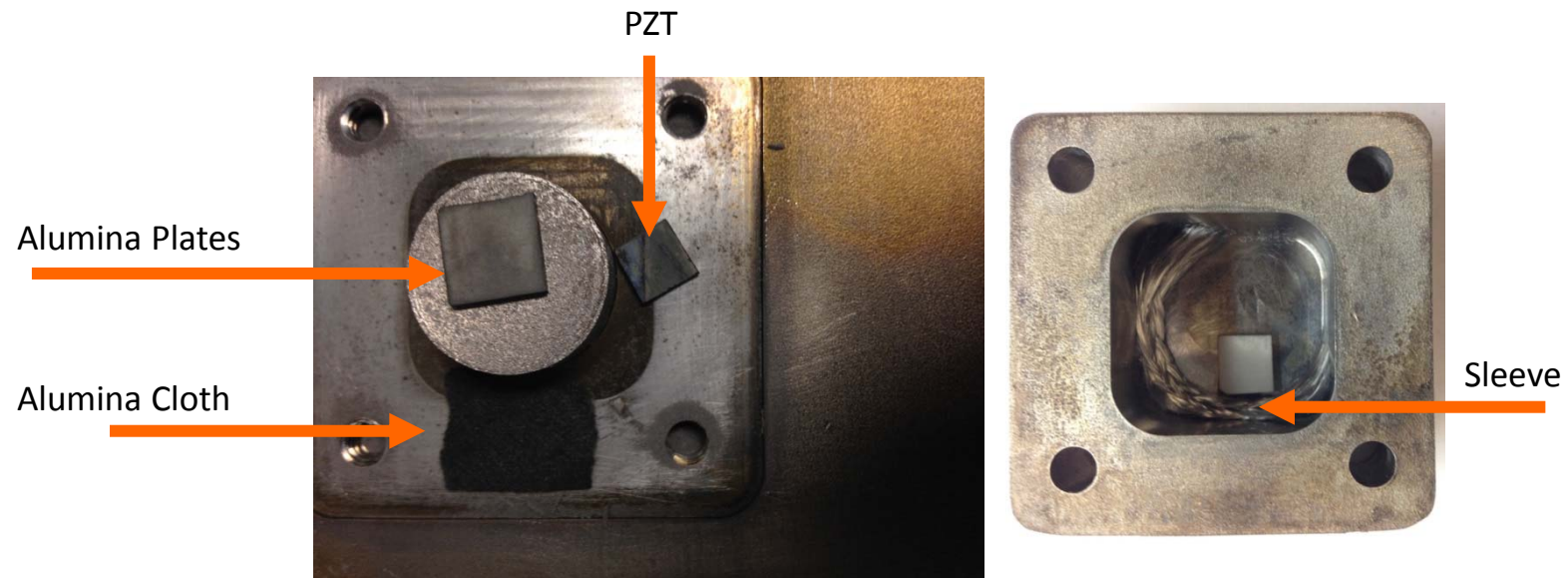

Bottom of start plate after EBM

Sensor Packaging Design

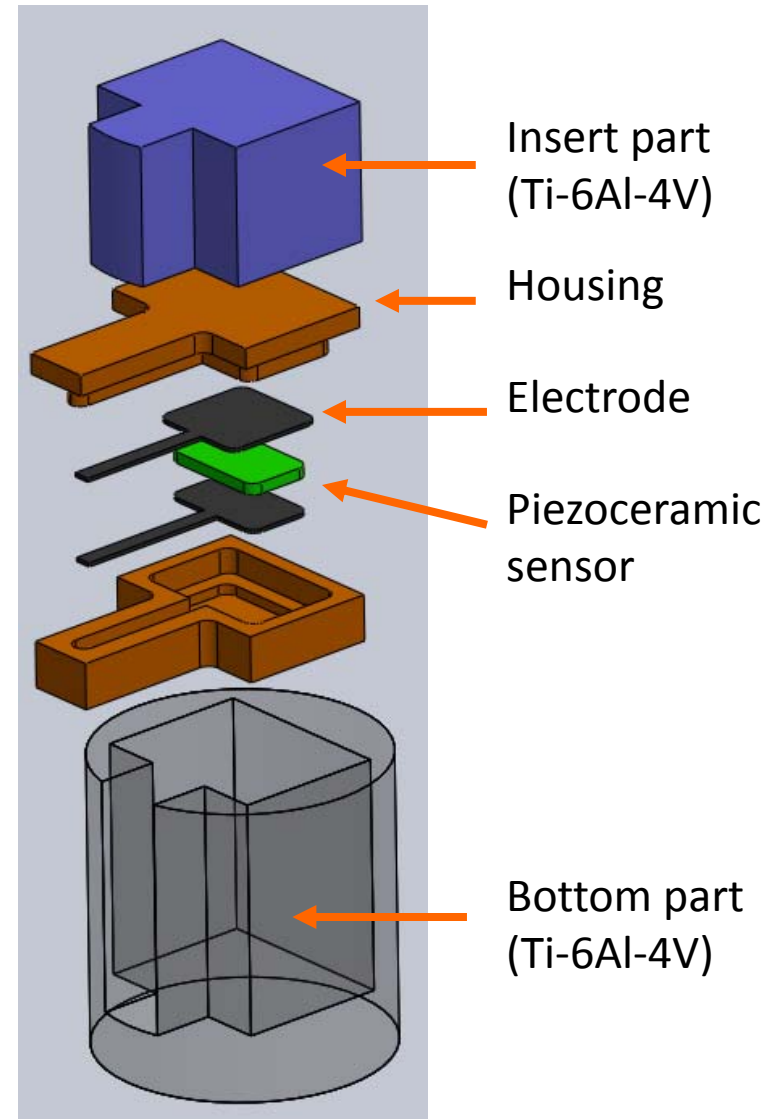
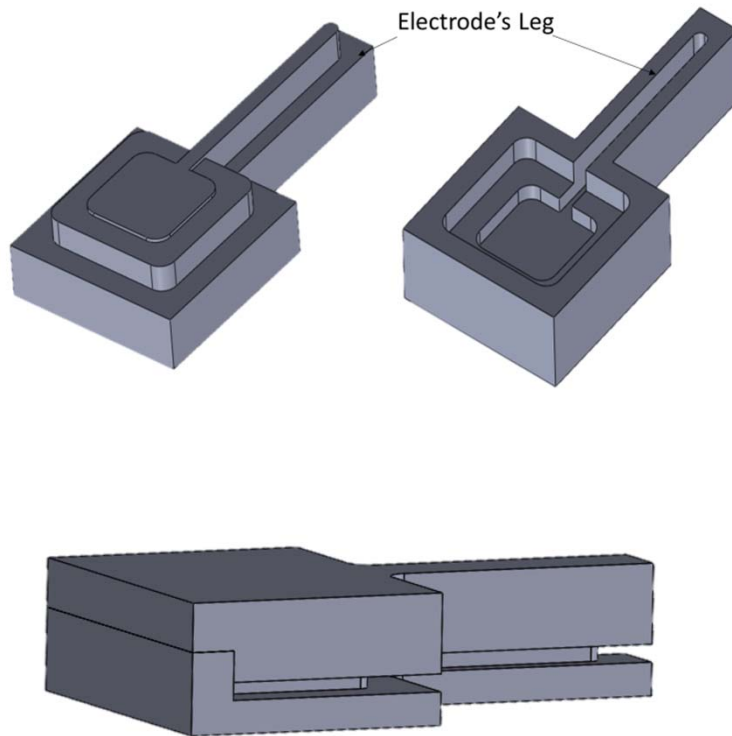

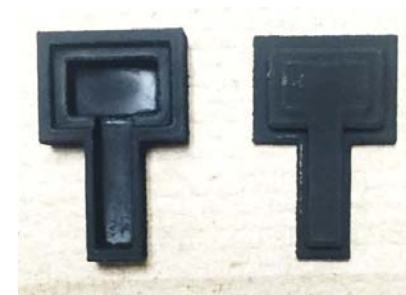
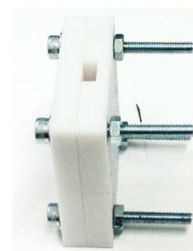
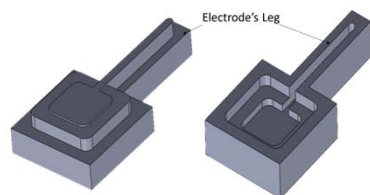

Machinable
Alumina



3D printing

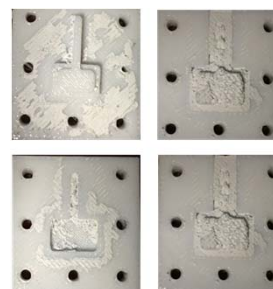

Injection
Modeling

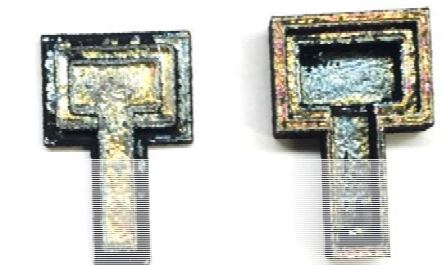

3D printing
+
Ceramic spray

Smart parts Fabrication (1st run)



Before
Fabrication



Final Part

Successfully Fabricated Smart Parts

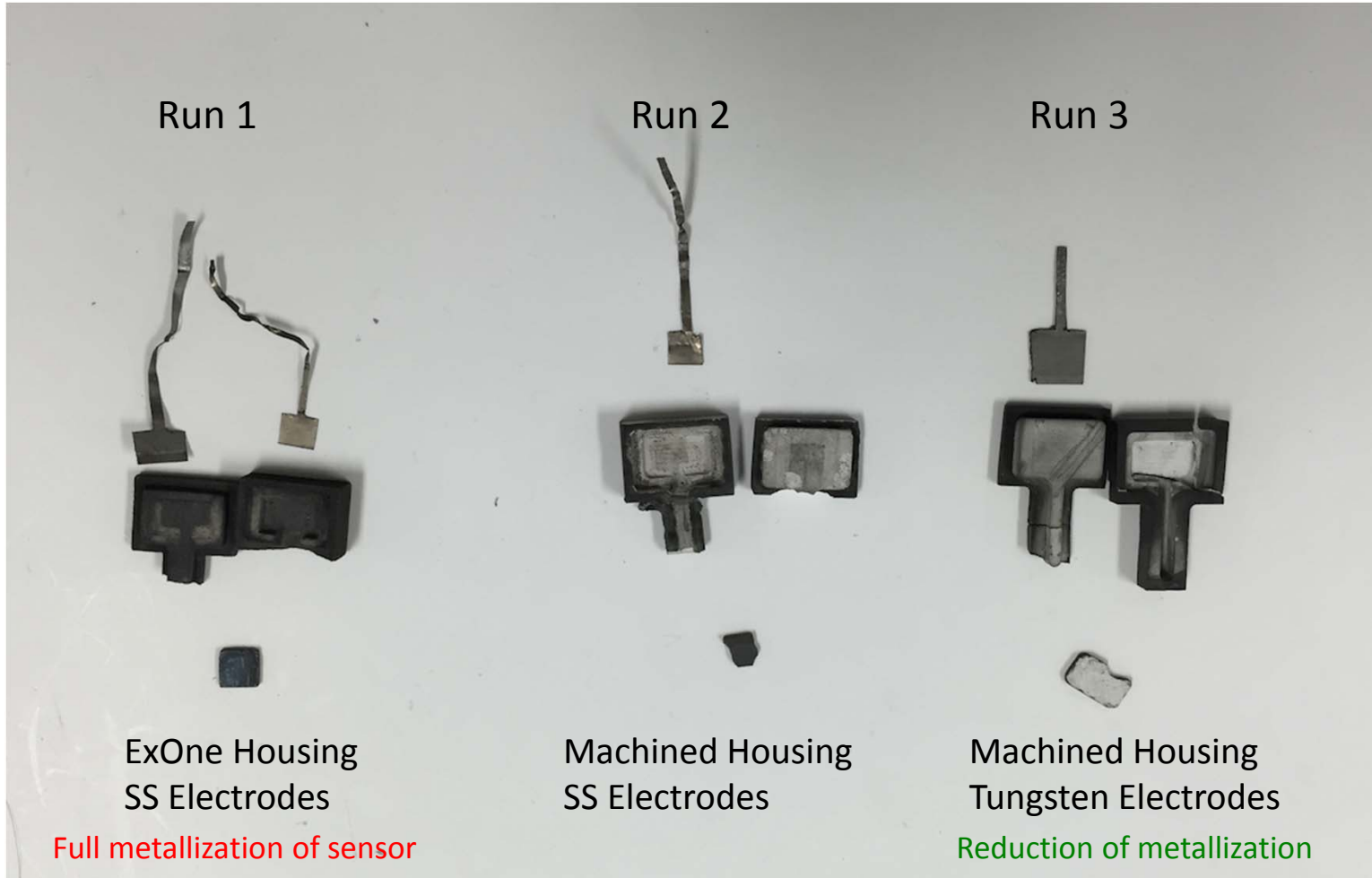



Modified Stop and Go Process

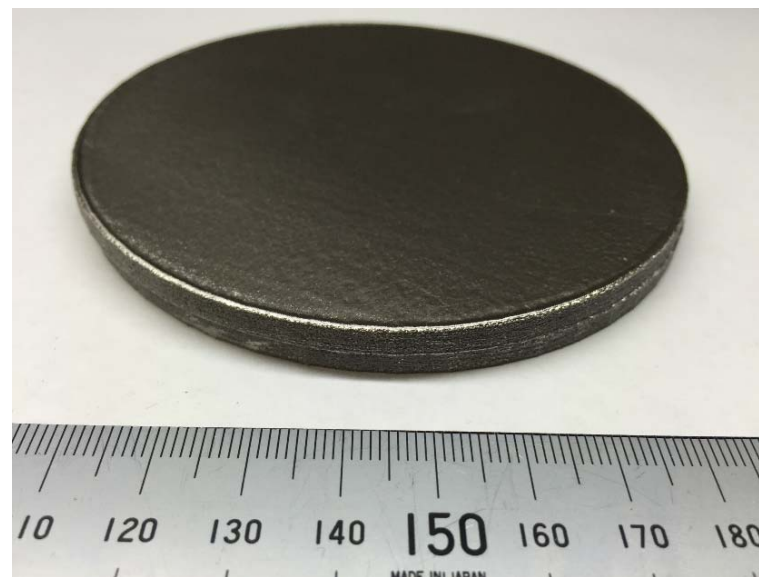
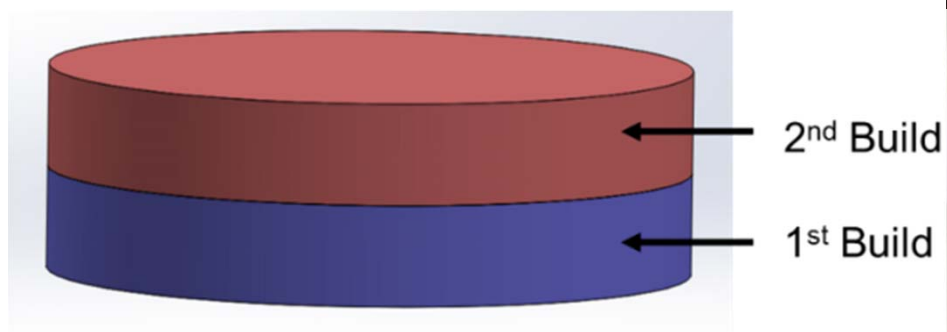

Hardness Testing Results

- Vickers Hardness Test was performed on the completed smart part
- No large change in Hardness value throughout the smart part
- EBM Ti-6Al-4V = 40 HRC [5]
- Annealed Ti-6Al-4V = 36 HRC [6]

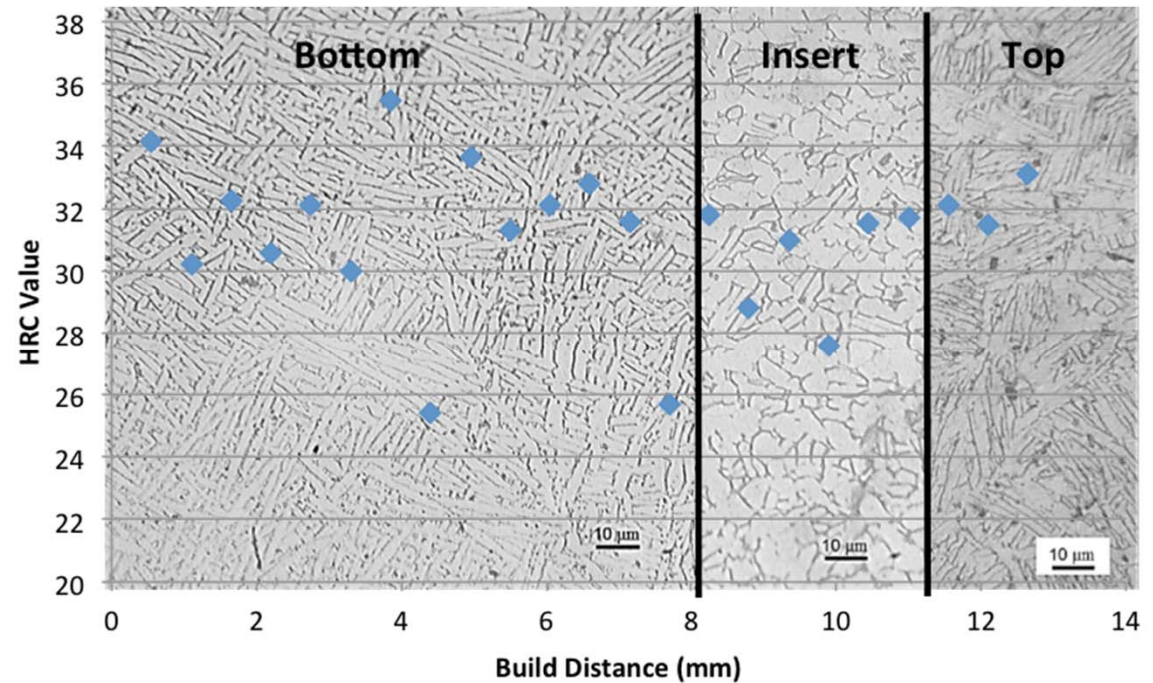

Force Sensing

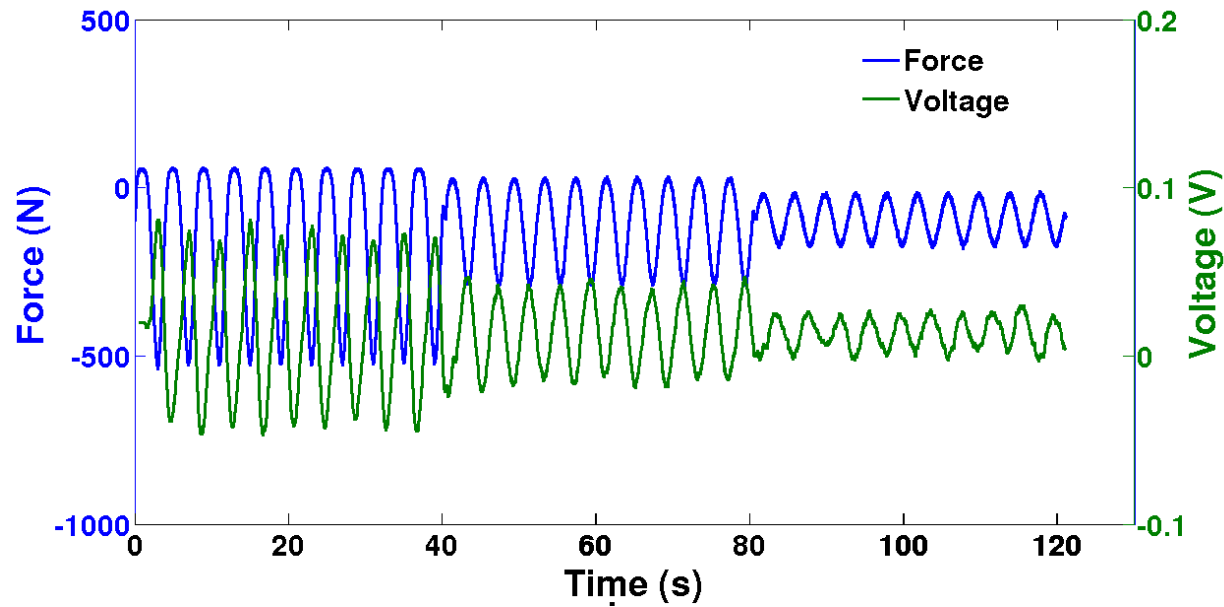

Force-Voltage
Correlation

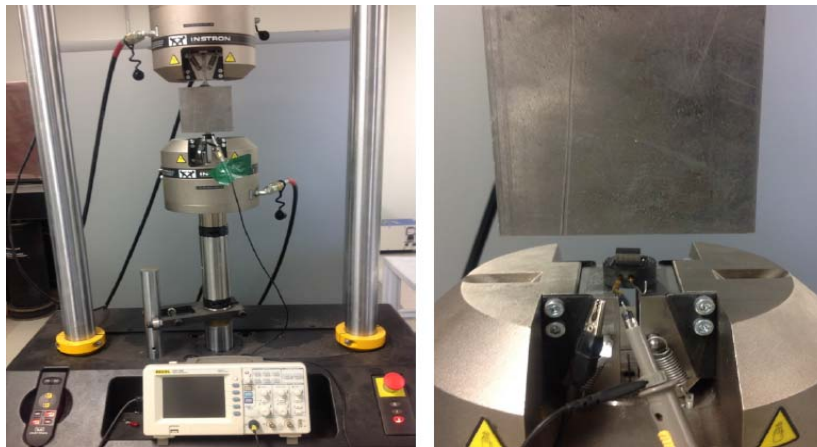

Temperature Sensing



PZT sample - Dielectric constant vs. temperature at 1 kHz

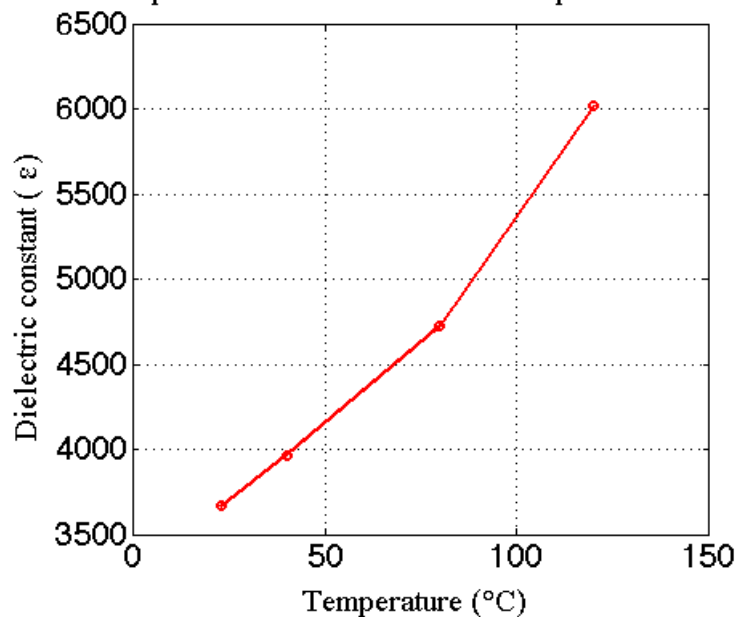

PZT sample - Dielectric loss vs. temperature at 1 kHz

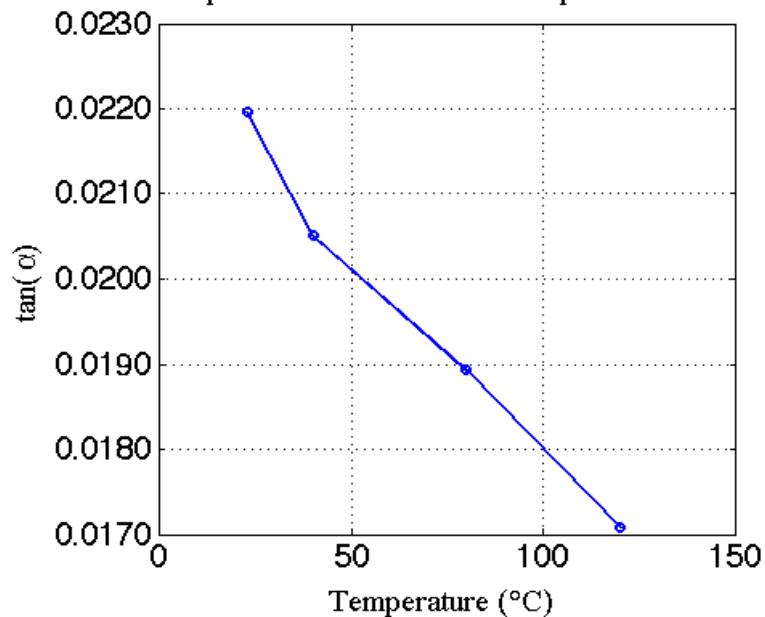



Fabrication of Energy System Components

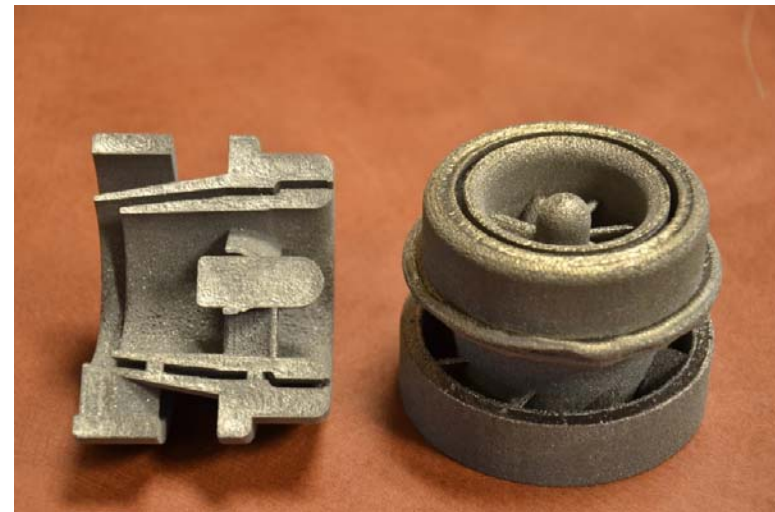
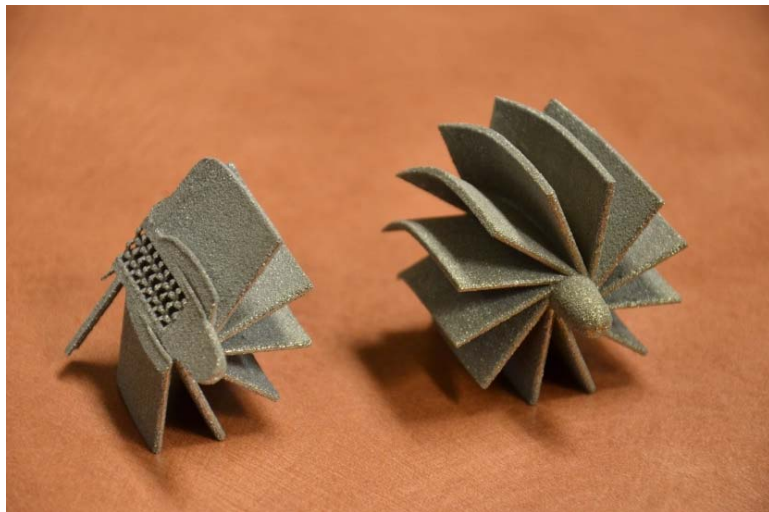
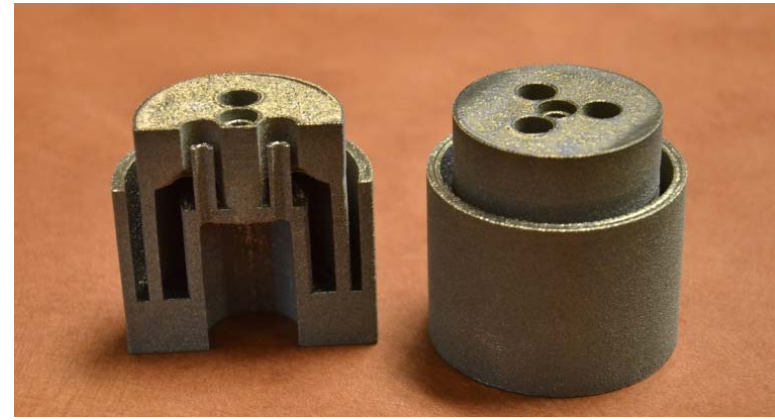
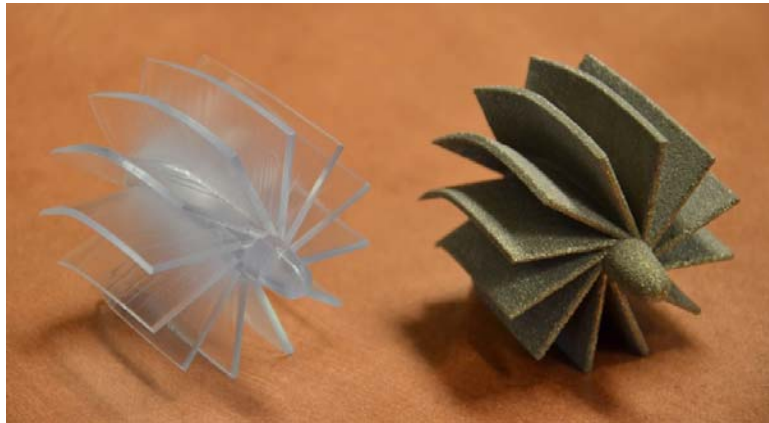

Future Work

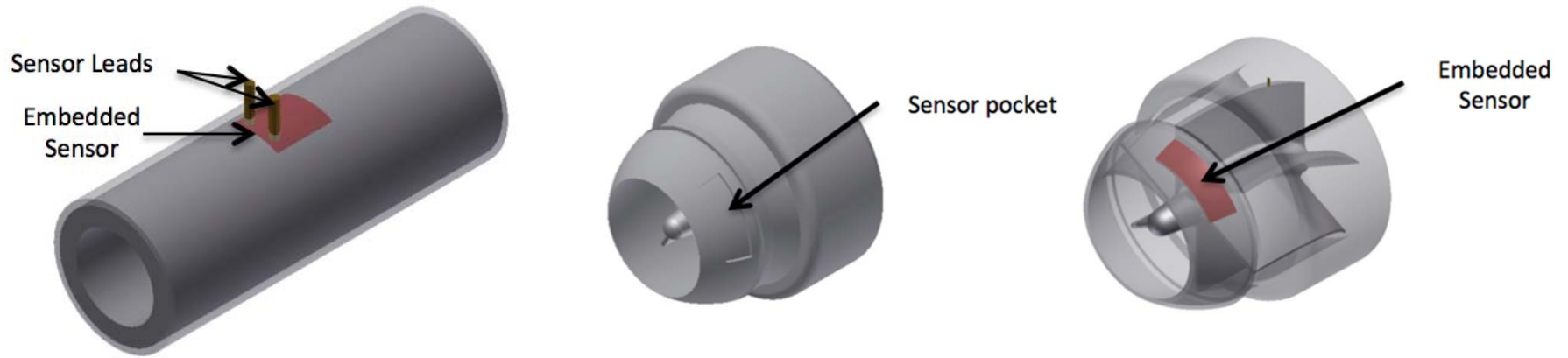

Smart tube with embedded sensor

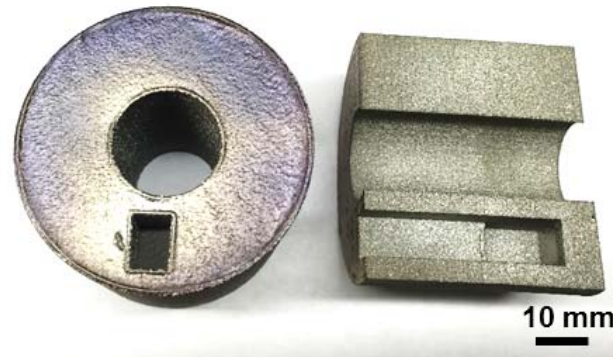



Acknowledgment

- Funding support by the U.S. Department of Energy (DOE), award No. DE-FE0012321
- Program Manager: Maria Reidpath





Thank you
Questions?